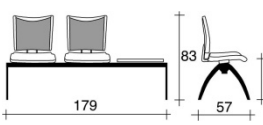
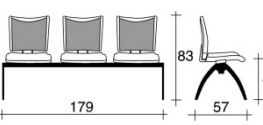
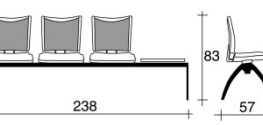
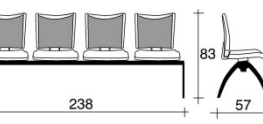
 <p>3600/B2</p>	 <p>3600/B2T</p>
 <p>3600/B3</p>	 <p>3600/B3T</p>
 <p>3600/B4</p>	