 <p>030</p>	 <p>030/H</p>	 <p>031</p>	 <p>032/TDX</p>
 <p>035</p>	 <p>035/H</p>	 <p>035/R</p>	
 <p>035 HR (super reinforced frame)</p>	 <p>036</p>	 <p>035/R HR (super reinforced frame)</p>	
 <p>038</p>	 <p>038/TDX</p>	 <p>038/R</p>	 <p>038/RTDX</p>
 <p>040</p>	 <p>040 TAB</p>	 <p>041</p>	

TREK

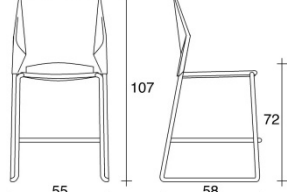
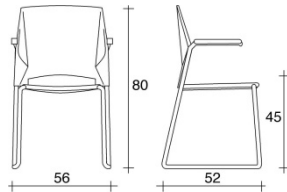
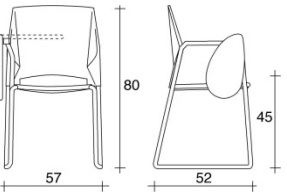
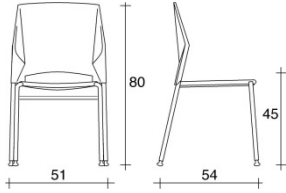
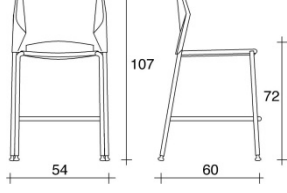
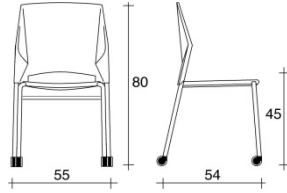
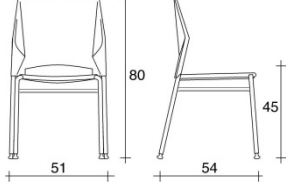
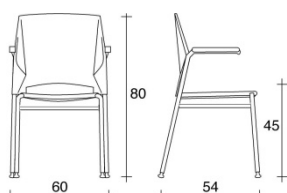
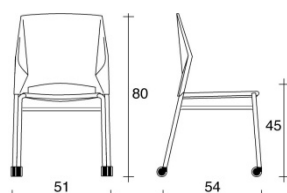
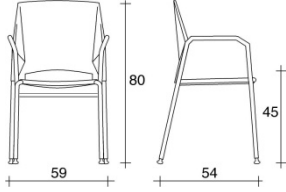
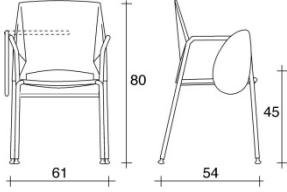
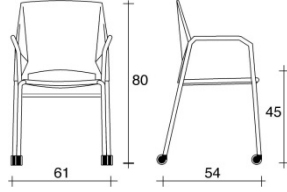
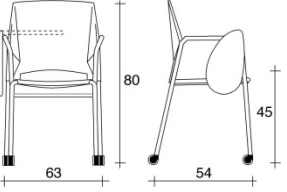
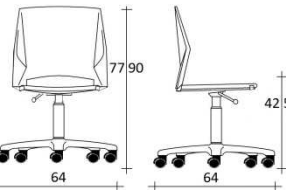
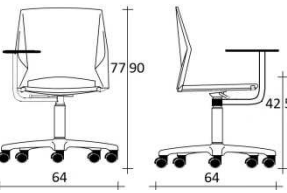
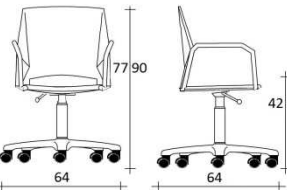
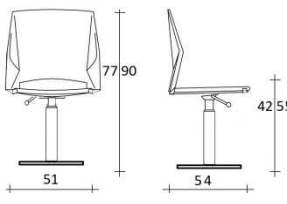
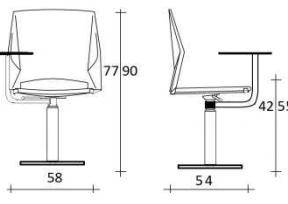

 <p>040/F</p>	 <p>040/F TAB</p>		
--	--	--	--